

CGK SERIES Light Duty Plate

50mm, 75mm, 100mm (75mm & 100mm come with Zinc Guards)



CGKGRA50STB









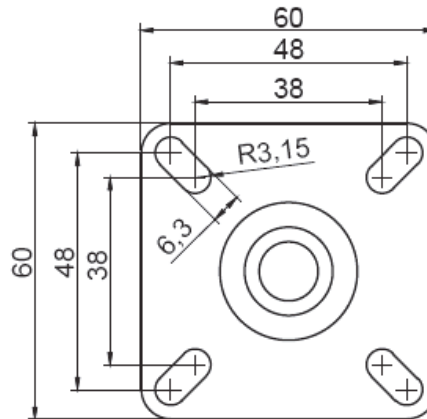























CGKGRQ75STB
CGKGRQ100STB

Capacity: 40 - 70KG per castor

- Zinc Plated Frame
- Double Ball Bearing Raceways
- Non- Marking Grey TPR Rubber (85 - 90 shore A)
- Dual Precision Bearing wheels 75mm & 100mm (50mm plain Bearing)
- Suit light duty applications
- Attached by welding or using bolts or wood screws (6.3mm mounting holes)



TYPE	CODE	WHEEL DIAMETER (MM)	TYRE WIDTH	WHEEL TYPE	BEARING TYPE	PLATE SIZE	HOLE CENTRES MM	CAPACITY	HEIGHT (MM)
SWIVEL	CGKGRA50S	50	18						
SWIVEL / BRAKE	CGKGRA50STB	50	18						
SWIVEL	CGKGRQ75S	75	23						
SWIVEL / BRAKE	CGKGRQ75STB	75	23						
SWIVEL	CGKGRQ100S	100	23						
SWIVEL / BRAKE	CGKGRQ100STB	100	23	